

# RLX 780

## Parts Guide



<u>Category</u>	<u>Page Number</u>
Electrical Cabinet	2-3
Motor's, Cable's & Drives	4-5
Switches & Buttons	5-6
Handwheel & Jog Stick	6-7
Pendant & Module	7
Pumps	6
Other Electrical Parts	7-8
Pneumatic & Coolant	9
Main Door & Windows	9-10
Belt's	10
Drag Chain & Wipers	11
Tooling Inc Chucks/Toolpost/ Steady & Drilling Attachment	11-13

## Electrical Cabinet

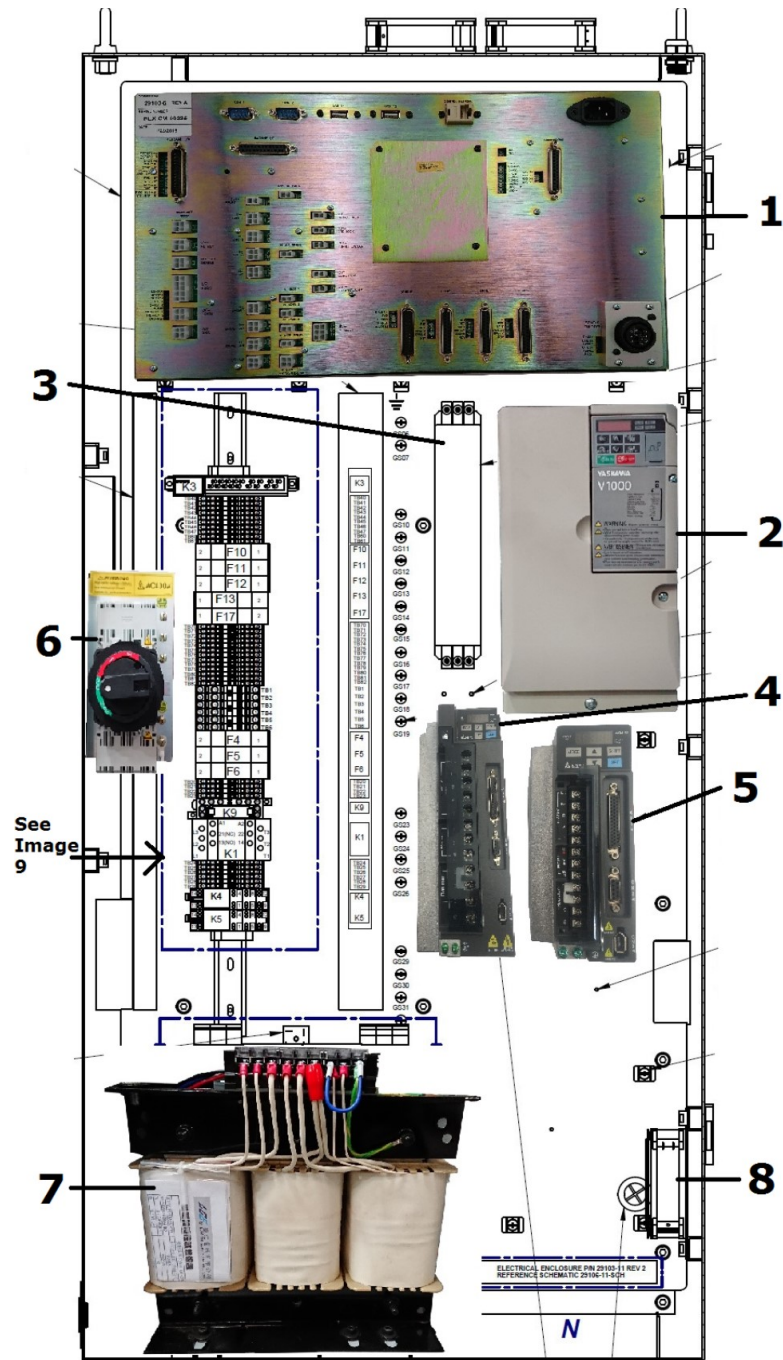

<u>Item Number</u>	<u>Description</u>	<u>XYZ Part Number</u>
1	RLX Computer Module	18400
2	Inverter 22 KW	17767
3	Schaffner Line Filter	16782
4	Delta Servo Driver 1KW	18365
5	Delta Servo Driver 3KW	17623
6	Door Isolator Switch 75A	17118
7	Transformer 3 Phase	18769
8	Cabinet Fan 220V AC	14663

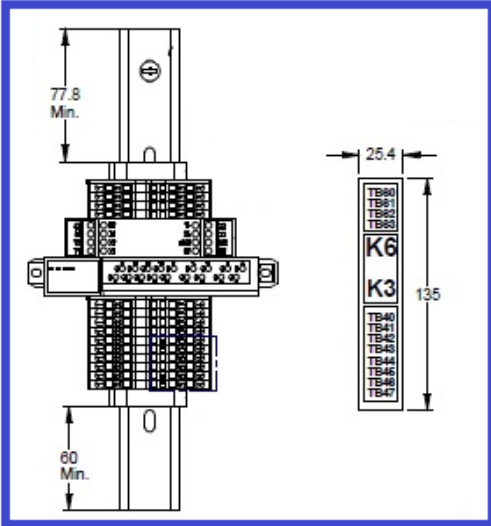

ITEM	Description	XYZ Part Number
K6	Elmon Rail 39-726	16113
K3	Omron G9SE-401 24v DC	15052

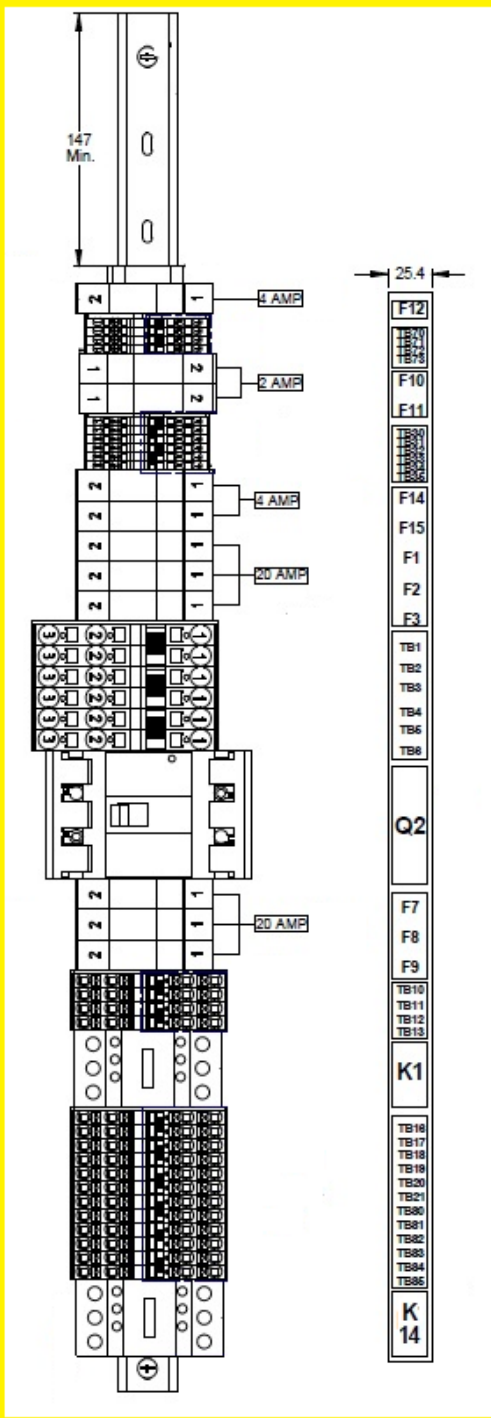

F12	Fuse 4 A 10x38mm	6622
F10	Fuse 2 A 10x38mm	6616
F11	Fuse 2 A 10x38mm	6616
F14	Fuse 4 A 10x38mm	6622
F15	Fuse 4 A 10x38mm	6622
F1	Fuse 20 A 10x38mm	6620
F2	Fuse 20 A 10x38mm	6620
F3	Fuse 20 A 10x38mm	6620
Q2	Fuji BW50 EAG 50A, inc handle	16915
F7	Fuse 20 A 10x38mm	6620
F8	Fuse 20 A 10x38mm	6620
F9	Fuse 20 A 10x38mm	6620
K1	Tele Contactor LC1 D25 24vDC	18481
K14	Tele Contactor LC1 D25 24vDC	18481
&	Tele Aux LA DN 40	18483

K4	Omron Relay MY2-GS DC24	16270 + 16271
K5	Tele Contactor LC1 9A 24vDC	18482
& Q5	Tele Overload LR3D06 1-1.6	6399
F20	Fuse 4 A 10x38mm	6622
F21	Fuse 4 A 10x38mm	6622
F22	Fuse 4 A 10x38mm	6622
K11	Tele Contactor LC1 9A 24vDC	18482
& Q11	Tele Overload LR3D06 1-1.6	6399
K12	Tele Contactor LC1 9A 24vDC	18482
Q14	Tele Breaker GV2ME03 0.25-0.4A	6136

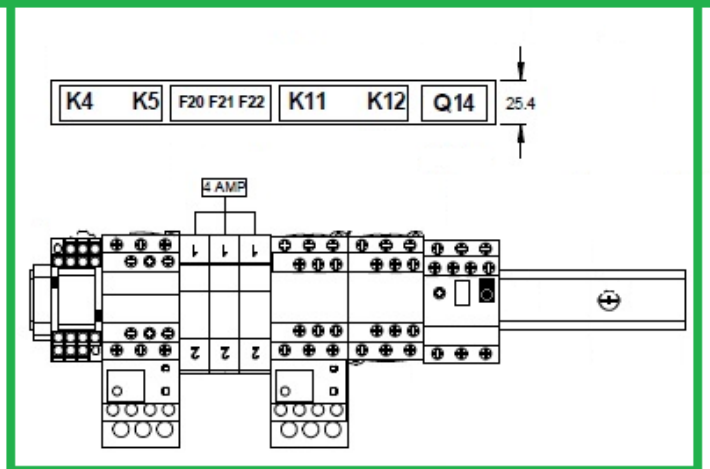

## Motor's, Cable's & Drives

<u>Description</u>	<u>XYZ Part Number</u>	
X Axis Motor	13641	
Z Axis Motor	17662	
X Axis Drive	18365	
Z Axis Drive	17623	
X Axis Motor Encoder Cable	17523	
X Axis Motor Power Cable	17522	
Z Axis Motor Encoder Cable	17525	
Z Axis Motor Power Cable	17524	

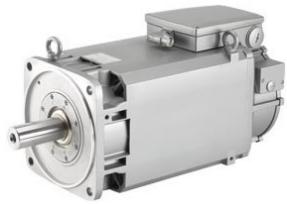

## Motor's, Cable's & Drives

<u>Description</u>	<u>XYZ Part Number</u>	
Main Spindle Motor	17677	



## Switches, Buttons & Relays

<u>Description</u>	<u>XYZ Part Number</u>	
E-Stop Button	16273	
Rear Chuck Interlock Panel Switch	14337	
Chuck Guard Switch Key	Switch - 3351 Key - 14383	
Door Safety Strip Fits Left & Right	16999	
Safety Edge Controller Relay	16113	
Interlock For Access Via Sliding Panel To Main Chuck & Saddle	12677	

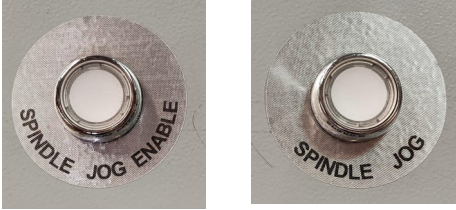

## Switches, Buttons & Relays

<u>Description</u>	<u>XYZ Part Number</u>	
Door Isolator Switch 75A	17118	
Gear Selector Sensor Switches	7923	
Spindle Operation Switch / Conveyor Switch	18395	
Spindle Jog Button's	12316	

## Pump's

<u>Description</u>	<u>XYZ Part Number</u>	
Stairs Coolant Pump	16054	
AutoLube Pump	18388	

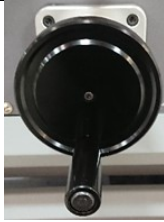

**Handwheel's & Jog Stick**

<u>Description</u>	<u>XYZ Part Number</u>	
Z Axis Handwheel	6932	
X Axis Handwheel	465	
Safety Jog Stick	15012	

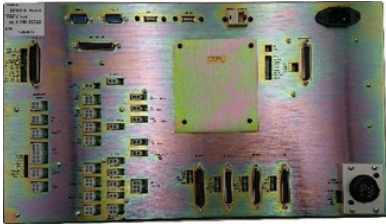
**Pendant & Module**

<u>Description</u>	<u>XYZ Part Number</u>	
RLX Pendant	17394	
Computer Module	17404	

**Other Electrical Parts**





<u>Description</u>	<u>XYZ Part Number</u>	
Inverter 22KW	17767	
Main Transformer	17231	

## Other Electrical Parts



<u>Description</u>	<u>XYZ Part Number</u>	
Brake Resistor	18393	
Spindle Encoder	17253	
Work light in Main Sliding Door	16160	
Work Light	15823	
RJ45 / Ethernet Connector	16268	
Electronic Handwheel & Apron Jog Stick Cable	17482	
Brake Resistor Fan 220V AC	18486	



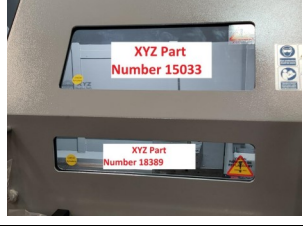

## Pneumatic & Coolant

<u>Description</u>	<u>XYZ Part Number</u>	
Air Regulator Unit	10962	
Tailstock Assembly Air Pipe	10218	
Coolant Nozzle Assembly	12585	
Armoured Coolant Pipe	18392	





## Main Door & Window's

<u>Description</u>	<u>XYZ Part Number</u>	
Small Bottom Window	18389	
Top Window	15033	
Window Silicon	11661	

## Chillers

<u>Description</u>	<u>XYZ Part Number</u>	
Main Heat Exchanger	18390	
Oil Chiller	18391	

## Belt's

<u>Description</u>	<u>XYZ Part Number</u>	
X Axis Belt	18376	
Z Axis Belt	17945	
Spindle Encoder Belt	18375	
Spindle Belt Set	13888	

## Drag Chain / Wiper's

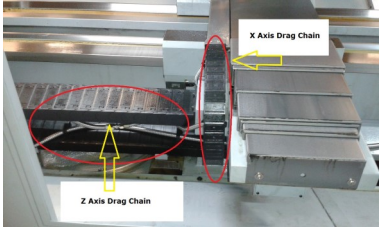
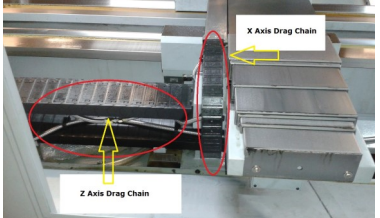
<u>Description</u>	<u>XYZ Part Number</u>	
Z Axis Chain 2300mm Long	17228	
X Axis Chain 612mm Long	17227	



## Chuck's

<u>Description</u>	<u>XYZ Part Number</u>	
500mm Scroll 3 Jaw Chuck Supplied With The Machine	13770	
630mm Independent 4 Jaw Chuck <b>Cast Iron</b>	13840	
630mm Independent 4 Jaw Chuck <b>Steel</b>	18112	
16" Rear Mount Chuck	18038	
Chuck Guard For 630mm 4 Jaw Chuck	13980	

## Chuck's

<u>Description</u>	<u>XYZ Part Number</u>	
Chuck Guard For Rear Mount Chuck	18033	
Soft Jaws To Suit 500mm 3 Jaws Chuck	13947	
Soft Jaws For 630mm 4 Jaw Chuck	15532	
Extended Chuck Key For 500mm Chuck	14047	
Extended Chuck Key For 630mm Chuck	14604	

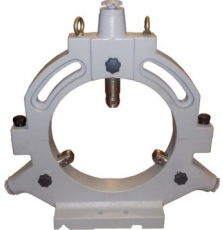
## Steady Options

<u>Description</u>	<u>XYZ Part Number</u>	
Fixed Steady 30-550mm	13798	
Travelling Steady 20-190mm	13800	

## Tool Post / Holders

<u>Description</u>	<u>XYZ Part Number</u>	
S4 Quick Change Tool Post Set	8401	
S4 Standard Holder	8431	
S4 Vee Holder	8950	
S4 Morse Holder	8948	
S4 Plain Bore 50mm Holder	18085	

## Drilling Attachment's

<u>Description</u>	<u>XYZ Part Number</u>	
Drilling Attachment 70mm Bore	13795	